

Kaisi[®]

K-9033 DIGITAL MULTIMETER

CAT VI 600伏
数字万用表

Instructions User Manual
用户手册

Limited warranty and scope of liability

This product from the date of purchase, will be able to enjoy a year of material and process on the warranty, but this warranty does not cover fuses (fuses), disposable batteries (used), or due to accident, negligence, abuse, Pollution, and the operating environment of the abnormal and the formation of damage. The retailer has not been extended by the Guangzhou Kings Trading Co., Ltd. to upgrade the contents of the warranty, warranty period, for service, you can contact the company after-sales service, access to authorized information, and then send the product to the center, accompanied by fault instructions.

The warranty is the only warranty that you can obtain for compensation. In addition to this, there is no warranty for a particular purpose, and shall not be liable for any special, indirect, incidental, conclusive or consequential damages. This limitation of liability may not apply to you because a State does not allow exclusion or limitation of implied warranties or incidental or consequential damages.

CONTENTS

Overview.....	1
Safety Precautions	2
General characteristics	3
Technical characteristics	
Accuracy.....	4
Performance	4
Voltage	5
Current	6
Resistors	7
NCV testing	7
Capavitor.....	8
Frequency	8
Temperature.....	9
Diode on and off testing	9
Display screen.....	10
Operation panel.....	11

Measurement





Voltage Measurement	12
Current Measurement.....	14
Resistance Measurement.....	16
Capacitance Measurement.....	18
Diodes and on-off test	19
Frequency Measurement.....	19
Data hold / on and off of backlight.....	20
Automatic turn on/off machine.....	20
Troubleshooting.....	21
Instrument Maintenance.....	22

Overview

K-9033 digital instrument.20000 counts is a 4 1/2 digital instrument, is a high precision, stable performance, battery-driven high reliability and high accuracy automatic digital multimeter. The instrument has a 21mm character height super big LED screen and it can be read the value clearly and has a function of keeping peak value,it also can be used to measure DC voltage and AC voltage, DC current and AC current, resistances, capacitors, diodes, temperature, on and off, electric field induction testing, frequency and other parameters.The whole machine use double integral A / D conversion for core, is a superior performance instrument, is the laboratory, factories, radio enthusiasts and the ideal home tools.

Safety Precautions

The series of instruments in the design in line with IEC1010 (International Electrotechnical Commission issued by the safety standards), before use, please read safety precautions first.

- 1. When measuring the voltage, do not input more than 1000V DC or AC 750V RMS voltage limit;
- 2. Voltage below 36V is the safety voltage, measured at 36V DC, 25V AC voltage, you need to check whether the testing lead is reliable contact, whether the correct connection, whether the insulation is good, to avoid electric shock;
- 3. For converting the function and range, the testing lead should leave the test point;
- 4. You should select the correct function and range, beware of misuse, the series of instruments have full range of protection, but for safety reasons, please pay more attention;
- 5. When measuring the current, do not enter more than 10A current;
- 6. The meaning of safety symbols: “” means there is dangerous voltage, “” means connection with ground, “” means double insulation, “” means the operator must refer to the instructions, “” means low voltage symbol.

General characteristics

Display	LCD display
Maximum display	20000 (4 1/2) bit automatic polarity display
Measurement method	double integral A / D conversion
Sampling rate	about 3 times per second
Overrange display	the highest bit was“OL”
Low voltage display	“  ” symbol appears
Working environment	(0~40) °C
relative humidity	<80%
Power	9V (NEDA1604 / 6F22)
Volume (size)	184x90x46 mm(lengthxwidthxheight)
Weight	about 320g (including 9V battery)
Annex	a manual, a certificate, one of the outer box, a pair of test pencil, K-type thermocouple Tp01 and 9V (NEDA1604 / 6F22 or equivalent models)

Technical characteristics—Accuracy

Accuracy: (a% + minimum number of digits).

To ensure the accuracy of the ambient temperature: (23.5)°C, relative humidity <75%.

Calibration guarantee period from the date of the factory for one year.

Performance

“▲” indicates that the table has this function

Function	K-9033	Function	K-9033
DC Voltage	▲	Temperature °C/F	▲
AC Voltage	▲	Auto-off	▲
A/DC Current uA	▲	Back light display	▲
A/DC Current 10A	▲	Unit symbol display	▲
resistors, diodes, on and off	▲	RMS value testing	▲
capacitors, C	▲	Electric field testing	▲
Frequency f	▲		

DC voltage(DCV)

Range	Accuracy	K-9033	Resolution ratio
200mV		(0.05%+5)	0.01mV
2V			0.0001V
20V			0.001V
200V			0.01V
1000V		(0.08%+10)	0.1V

Input impedance: 10M Ω ;

Overload protection: 200mV range of 550V DC or AC peak;
the remaining 1000V DC or 750V AC peak.

AC voltage is really valid(ACV)

Range	Accuracy	K-9033	Resolution ratio
200mV		(0.6%+25)	0.01mV
2V			0.0001V
20V			0.001V
200V			0.01V
750V		(0.8%+15)	0.1V

Input impedance: 10M Ω ;

Standard sine wave and triangular wave frequency response of 40Hz-1kHz;
other waveform frequency response 40Hz-200Hz;

DC current

Range	Accuracy	K-9033	Resolution ratio
200μA		(0.5%+4)	0.01μA
2000μA			0.0001mA
20mA		(0.8%+6)	0.001A
200mA			0.01A
10A			0.1A

Maximum measurement pressure drop:200mV; Maximum input current of 10A;
 Overload protection: 200mA/250V glass instant fuse,
 10A / 250V ceramic instant fuse (10A continuous measurement <10 seconds)

Alternating current

Range	Accuracy	K-9033	Resolution ratio
200μA		(0.5%+4)	0.01μA
2000μA			0.0001mA
20mA		(0.8%+6)	0.001A
200mA			0.01A
10A			0.1A

Maximum measurement pressure drop:200mV; Maximum input current of 10A;
 Overload protection: 200mA/250V glass instant fuse, 10A / 250V ceramic instant fuse (10A continuous measurement <10 seconds)The frequency of the sub-display frequency when

measuring the AC voltage threshold voltage is greater than 12mV only frequency display; Frequency response: sine wave and triangular wave for the 40Hz-1Kz, other wave form 40Hz-200Hz; Show: True RMS;

Resistors

Range	Accuracy	K-9033	Resolution ratio
200Ω		(0.3%+10)	0.01Ω
2 kΩ		(0.3%+5)	0.1Ω
20kΩ			1Ω
200kΩ			10Ω
2 MΩ			100Ω
20MΩ		(1.2%+25)	1kΩ

Open circuit voltage:below 3V;Overload protection:550VDC or AC peak value;

Notices:A.When you use the range of 200Ω, you should short the testing pencil at first, you will got the wire resistor,then subtract the value in the real testing;

B.When you test the resistor over1 MΩ,it is normal that the reading value will display slowly, you should read the value after the value is steady.

NCV testing

When convert the function to NCV and the instrument closing the electric field, the buzzing sound of the instrument will in line with the intensity of electric field.

Range	Accuracy	K-9033	Resolution ratio
20nF		(3.5%+20)	1pF
200nF			10pF
2μF			0.1nF
20μF			1nF
200μF		(5.0%+10)	10nF
2000μF			100nF

Overload protection:550V DC or AC peak value.

Frequency

Range	Accuracy	K-9033	Resolution ratio
10Hz		(0.01%+3)	0.001Hz
100Hz			0.01Hz
1kHz			0.1Hz
10kHz			1Hz
100kHz			10Hz
1MHz/20MHz			100Hz/1kHz

Input sensitivity:1.5V RMS;

Overload protection:550V DC or AC peak value(not over 10second).

Temperature

Range	Accuracy	K-9033	Resolution ratio
(-20-1000) °C		(1.0%+ 5) < 400 °C (1.5%+ 15) ≥ 400 °C	1 °C
(0-1832) °F		(0.75%+ 5) < 750 °F (1.5%+ 15) ≥ 750 °F	1 °F

Diode on and off testing

Range	Display value	Testing condition
	Positive diode voltage drop	Positive DC current about 1mA, Open circuit voltage about 3V
	Buzzer with long buzzing Sound the resistance of 2 testing point below (50±20)Ω	Open circuit voltage about 3V Press "SELECT" can convert the 2 function

Overload protection: 550V DC or AC peak value;

warning :For safety reason, please do not input a voltage value!

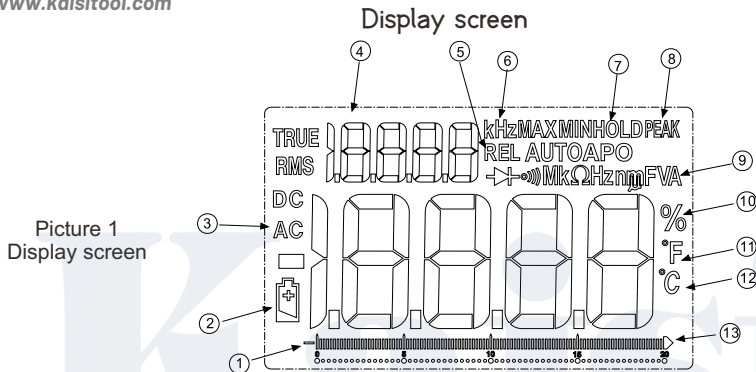

Picture 1
Display screen

ITEM	DESCRIPTION	ITEM	DESCRIPTION
①	Negative polarity display	⑦	Enable “keep reading value”
②	Battery has insufficient electricity, should change at once	⑧	Enable “keep peak value”
		⑨	current symbol
③	AC symbol	⑩	Percentage
④	secondary display	⑪	Fahrenheit
⑤	Enable relative value testing	⑫	Celsius
⑥	secondary display frequency indication	⑬	Simulated bar indication

Operation panel

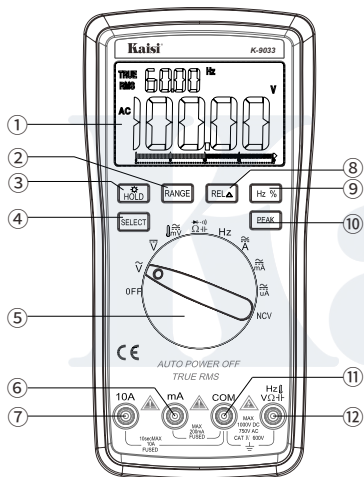

Picture 2
Operation panel

ITEM	DESCRIPTION
①	LCD display
②	Range converter
③	Keep reading value, Long press 3seconds to convert to backlight mode
④	Function selection key
⑤	Function converting button
⑥	“mA” “+” input hole
⑦	“10A” “+” input hole
⑧	REL relative testing value key
⑨	Frequency percentage convert key
⑩	“PEAK” is peak value key
⑪	COM input point/negative input point/ input hole
⑫	Voltage/resistance/diode/capacitor/ frequency/temperature/“+” input hole

Measuring AC voltage and DC voltage

- 1.Convert the rotary switch to \tilde{V} \bar{V} or $\sqrt{\text{mV}}$ choose DC/AC voltage.
- 2.Press“SELECT”could convert mVDC between mVAC voltage.
- 3.Connect red wire to $\overset{\text{Hz}}{\text{V}}$
- 4.In order to test the voltage ,using test lead connect to correct testing point ,in picture 3.
- 5.Read the voltage value on the screen.

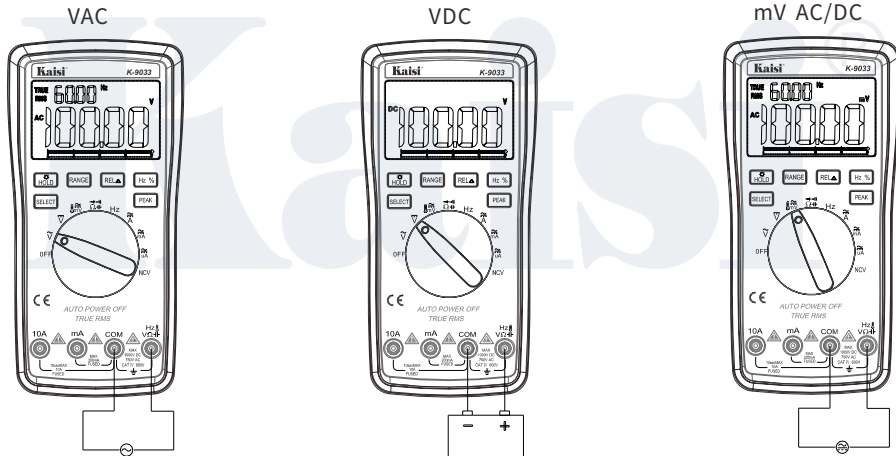

Picture 3 Measuring voltage

Measuring the DC voltage

1. Insert the black test lead into the "COM" jack and the red test lead into the "V/ Ω /Hz" jack of.
2. Turn the range switch to \bar{V} or \bar{mV} , when the measured value is less than DC 600mV select the gear \bar{mV} trigger "SELECT" key to switch between DCmV / ACmV.
3. The test meter pen can be selected to touch the test point, the screen shows the measured voltage value, for the red pen connect the voltage polarity of the point.

NOTICE: 1) Do not exceed the input voltage of DC1000V or AC750V, otherwise there exist the risk of damage to the instrument circuit.

- 2) When measuring high voltage circuit, pay special attention to avoid electric shock
- 3) After completing all the measurement operations, disconnect the test leads from the circuit under test.

Measuring the AC voltage

1. Insert the black test lead into the "COM" jack and the red test lead into the "V/ Ω /Hz" jack of.
2. Turn the range switch to \bar{V} or \bar{mV} , when the measured value is less than DC 600mV select the gear of \bar{mV} trigger "SELECT" key to switch between DCmV / ACmV.

NOTICE: 1) There are some residual numbers in each range before the test, but does not affect the measurement accuracy;

2) The input voltage should not exceed 750Vrms, otherwise there may exist the risk of damage to the instrument circuit:

3) After completing all the measurement operations, disconnect the test leads from the circuit under test.

Measure AC current or DC current

WARNING

To prevent possible electric shock, fire or personal injury, while measure Current, firstly disconnect power supply circuit, and then connect the meter to the circuit, the product will be connected in series with the circuit.

- 1. Turn the rotary switch to " \tilde{A} " " \tilde{mA} " " $\tilde{\mu A}$ " the current gear of
- 2. Press the "SELECT" key to switch between AC and DC current.
- 3. Connect the red test leads to the A or mA, uA terminals, and connect the black test leads to the COM terminal according to the current to be measured. in picture 4.
- 4. Disconnect the circuit path which to be tested. The test leads are then disconnected and the power supply is applied
- 5. Read the measured fluid on the display.

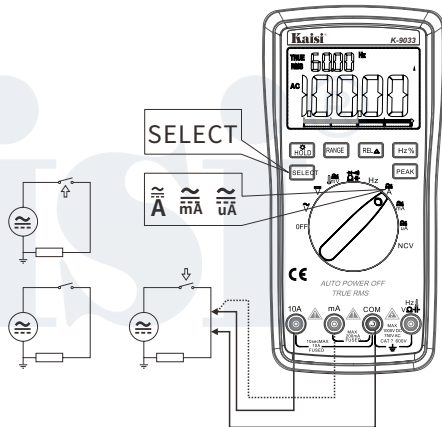

Picture 4
Measuring current

Measure AC current or DC current

1. Insert the black test lead into the "COM" jack and insert the red test lead into the "mA" or "uA" jack (up to 20mA), or the red test lead Insert "10A" (maximum 10A); the current default is the DC current, "SELECT" for the AC and DC current conversion key.

2. Turn the range switch to the corresponding current range, and then string the meter into the circuit to be tested. The current value of the measured current and the current polarity of the red pen will be displayed on the screen at the same time.

Notice:

- 1) Before the instrument is connected in series to the circuit to be tested, turn off the power in the circuit.
- 2) If there is no concept of the measured current range in advance. The range switch should be transferred to the highest gear, and then according to the display value to the corresponding file: If the screen was "OL", indicating that the range has been exceeded, the range switch should be transferred to the corresponding gear position;
- 3) The maximum input current of 200mA or 10A (depending on the red pen insertion position may be), too much current will damage the mA fuse file, pls pay attention while measure 10A, each measurement time shall not be longer than 10 seconds, too much current will make the circuit heat, or even damage the instrument:
- 4) When the test leads are inserted in the current input port, do not put the test leads in parallel to any circuit, otherwise will damage the fuses and instruments;
- 5) After the completion of all the measurement operations, you should first turn off the power and then disconnect the test pen and test circuit, the measurement of high current is more important.
- 6) Do not input larger than 36VDC, 25V AC voltage between the current jack and the "COM" jack.

Measuring Resistance

1. Turn the rotary switch to " Ω " to ensure that the power circuit to be tested is cut off.
2. Connect the red test leads to the VR port and connect the black test leads to the COM terminals as shown in Figure 5.
3. Touch the probe to the desired circuit test point and measure the resistance.
4. Read the resistance on the display. Continuity test

To test continuity

After selecting the resistive mode, press SELECT to enter the buzzer and the buzzer will sound continuously when the measured resistance is less than 50Ω

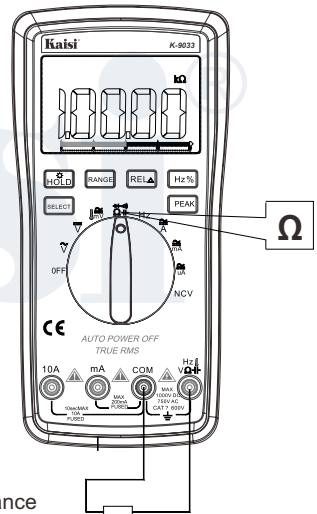

Picture 5
Measuring resistance

Measuring Resistance

1. Insert the black test lead into the "COM" jack and insert the red pen into the "V/ Ω /Hz" jack of.
2. Turn the dial to gear , trigger "SELECT" button, Select the automatic measurement of the resistance.
3. Then test the test leads across the measured resistance at both ends.

Notice:

- 1) If the measured resistance is open or the resistance exceeds the selected range value, the screen will display "OL". When the measured resistance value exceeds 1 M Ω or more, the reading takes a few seconds to stabilize, which is normal when measuring the high resistance;
- 2) When measuring the low resistance, the pen will bring the internal resistance. In order to obtain the correct reading, you can record the short value of the pen and subtract the value of the short of the test pen in the measurement reading.
- 3) When measuring the on-line resistance, it is necessary to turn off all the power of the circuit under test and discharge all the capacitors completely to ensure the correctness of the measured value.
- 4) Do not input voltage in the resistance range, which is absolutely prohibited, although the instrument has voltage protection function!

Capacitance Measurement

1. Insert the black test lead into the "COM" jack and insert the red pen into the "V/ Ω /Hz" jack of.
2. Turn the dial to gear , trigger "SELECT" button, Select the automatic measurement of the capacitor.
3. Then test the test leads across the measured capacitance at both ends.

Notice:

- 1). When measuring capacitance with 20nF, the screen display value may have residual reading. This number is the distributed capacitance of the test pen. In order to measure precisely, it can be used to subtract the value after the measurement.
- 2). Large capacitance measurement with serious leakage or breakdown of the capacitor, it will show some numerical and unstable; measurement of large capacitors, the reading takes a few seconds to stabilize, which during measured large capacitor is normal.
- 3). Before test capacitor capacity, the capacitor should be fully discharged to prevent damage to the fuse and the instrument.
- 4). Unit: 1 F = 1000mF
1mF = 1000 μ F
1 μ F = 1000nF
1nF = 1000pF

Diodes and on - off test

1. Insert the black test lead into the "COM" jack and insert the red pen into "V/ Ω /Hz" the jack of (note that the red pen has a polarity of "+");
2. Set the range switch to " $\overrightarrow{\Omega}$ " to trigger the "SELECT" key, select the diode measurement, and connect the test leads to the diode to be tested. The reading is an approximation of the forward voltage drop of the diode. For silicon PN junctions, 500mV ~ 800mV confirmed as normal: If the measured diode open or reverse polarity, then display "OL";
3. Trigger "SELECT" key, select the buzzer measurement, connect the test leads to the two points of the line to be measured. If the built-in buzzer sounds and the on-off alarm indicator is on, the resistance between the two points is less than about (50 \pm 20) Ω

NOTE: Do not enter the voltage in the " $\overrightarrow{\Omega}$ " gear, in case of damage the instrument.

Frequency Measurement

1. Insert the test leads or shielded cables into the "COM" and jack of "V/ Ω /Hz".
2. Turn the range switch to the frequency gear and connect the test leads or cables to the source of signal or to the load under test.

Note:

- 1). When the input exceeds 10Vrms, it can read, but it may be out of tolerance;
- 2). In a noisy environment, it is best to use a shielded cable when measuring small signals;
- 3). In the measurement of high voltage circuit, with particular attention to avoid electric shock;
- 4). Do not input more than 250VDC or AC peak voltage, in case of damage the instrument.

Data hold / on and off of backlight

Press the "HOLD" key to keep the data, long press" HOLD "for 3 seconds, the backlight is on, long press for 3 seconds, the backlight is off automatically.

Automatic turn on/off machine

When the instrument stops using for about 15 minutes later. The instrument will automatically turn off into the dormant state; if you need to restart the power, dial to OFF gear, turn the knob to other gears. Press and hold the "SELECT" button, and turn on the power switch, the screen "AP0" symbol disappears, it will cancel the automatic shutdown function.

Troubleshooting

If your instrument does not work properly, the following method will allow you to quickly solve the general problem. If cannot eliminate the faults, please contact the service center or dealer.

Failure phenomenon	Check the location and methods
Not shown	Battery not connected Replace the battery
 Symbol exit	Replace the battery
Current is not input	Replace fuse
Display error	Replace the battery

- This manual is subject to change without notice;
- The contents of this manual is considered correct, if the user found that there are errors, omissions, etc.please contact the manufacturer
- The Company does not assume any accidents and hazards caused by incorrect operation of the user;
- The functions described in this manual are not intended to be used for special purposes.

Instrument Maintenance

This series of instruments is a precision instrument. The user should not arbitrarily change the circuit.

1. Please be careful that waterproof, dustproof, drop.
2. Do not storage and use instrument in the high temperature and humidity, flammable and explosive and strong magnetic environment.
3. Please use a damp cloth and a mild detergent to clean the meter surface, do not use abrasive and alcohol and other strong solvents.
4. If you do not use for a long time, you should remove the battery to prevent the battery leakage to corrode the instrument.

Battery replacement

Pay attention to the battery usage, when the screen shows the  symbol, you should replace the battery, the steps are as follows:

- 1. Unscrew the screws that secure the battery cover and exit the battery cover:
- 2. Remove the battery, put on a new battery, although any standard battery can be used, for it's better to use alkaline batteries to lengthen the service time.
- 3. Install the battery cover and tighten the screws.

Fuse replacement

When replacing the fuse, use a fuse of the same type.

有限保修及责权范围

本产品自购买之日起,将可享受一年材料上及工艺上的质保,但此保修不包括保险丝(熔断)、一次性电池(用完)、或者由于意外事故、疏忽、滥用、改造、污染、及操作环境的反常而形成的损害。零售商没有被广州金卡思贸易有限公司扩充该保修的内容,质保期间,如需服务,您可联系本公司售后服务,获得认可信息,然后将产品送至该中心,并附上故障说明。

该保是您可获取补偿的唯一保修。除此之外,没有为特别的而制定的保修,对于任何特殊的、间接的、偶然的、并发性的损害或各种损耗,概不负责。因为有国家不允许对暗示保修或偶然的、并发性的损坏的排除或限制,上述责任限制也许不适用于您。

目 录

概述	26
安全须知	27
一般特性	28
技术特性	
精确度	29
性能	29
电压	30
电流	31
电阻	32
NCV测量	32
电容	33
频率	33
温度	34
二极管及通断性测试	34

显示屏	35
操作面板	36
测量	
测量交流电压和直流电压	37
测量交流电流和直流电流	39
测量电阻及通断性测试	41
测量电容	43
测试二极管及通断性测试	44
测量频率	44
数据保持/背光	45
自动开关机	45
故障排除	46
仪表保养	47





概述

K-9033是20000位4 1/2数字仪表,是一种高精度、性能稳定、用电池驱动的高可靠性高精度自动数字万用表。仪表采用 21 mm字高超大屏LCD 显示器,读数清晰,具有峰值保持功能,此仪表可用测量直流电压和交流电压、直流电流和交流电流、电阻、电容、二极管、温度、通断、电场感应测试及频率等参数。整机以双积分A/D转换为核心,是一台性能优越的工具仪表,是实验室、工厂、无线电爱好者及家庭的理想工具。

Kaisi®

安全须知

本仪表在设计上符合IEC1010条款(国际电工委员会颁布的安全标准),在使用之前,请先阅读安全注意事项。

- 1.测量电压时,请勿输入 超过直流1000V或交流750V有效值的极限电压;
- 2.36V以下的电压为安全电压,在测高于36V直流、25V交流电压时,要检查表笔是否可靠接触,是否正确连接、是否绝缘良好等,以避免电击;
- 3.换功能和量程时,表笔应离开测试点;
- 4.选择正确的功能和量程,谨防误操作,该系列仪表虽然有全量程保护功能,但为了安全起见,仍请您多加注意;
- 5.测量电流时,请勿输入超过10A的电流;
- 6.安全符号说明“”存在危险电压,“”接地,“”双绝缘,“”低电压符号。

一般特性

显示方式	液晶显示
最大显示	20000 (4 1/2) 位自动极性显示
测量方式	双积分式A/D转换
采样速率	约每秒钟3次
超量程显示	最高位显“OL”
低电压显示	“  ” 低电压符号出现
工作环境	(0~40)°C
相对湿度	<80%
电源	9V (NEDA1604 / 6F22)
体积(尺寸)	184x90x46 mm(长x宽x高)
重量	约320 g (包括9V电池)
附件	使用说明书, 合格证, 外包装盒, 表笔一对, K型热电偶TP01, 9V (NEDA1604 / 6F22或同等型号)

技术指标 —— 精确度

精确度在校准一年内适用, 环境温度为23.5°C, 相对湿度为<75%;

精确度规格显示为以下数值: \pm (【读数的a%】+【最小有效数字值】)

性能

“▲”表示万用表有此功能

功能	K-9033	功能	K-9033
直流电压DCV	▲	温度 °C/°F	▲
交流电压ACV	▲	自动断电	▲
交直流电流u A	▲	背光显示	▲
交直流电流10 A	▲	单位符号显示	▲
电阻/二极管/通断	▲	真有效值测量	▲
电容 C	▲	电场测量	▲
频率 f	▲		

直流电压(DCV)

量程	准确度	K-9033	分辨力
200mV	(0.05%+5)		0.01mV
2V			0.0001V
20V			0.001V
200V			0.01V
1000V	(0.08%+10)		0.1V

输入阻抗:10M Ω ;

过载保护:200mV量程为550V直流或交流峰值;其余为1000V直流或750V交流峰值。

交流电压真有效值(ACV)

量程	准确度	K-9033	分辨力
200mV	(0.6%+25)		0.01mV
2V			0.0001V
20V			0.001V
200V			0.01V
750V	(0.8%+15)		0.1V

输入阻抗:10M Ω ;

标准正弦波及三角波频响为40Hz-1kHz;其它波形频响为:40Hz-200Hz;

直流电流

量程	准确度	K-9033	分辨力
200μA		(0.5%+4)	0.01μA
2000μA			0.0001mA
20mA		(0.8%+6)	0.001A
200mA			0.01A
10A		(1.0%+6)	0.1A

最大测量压降:200mV;最大输入电流10A;

过载保护:200m A/250V玻璃速溶保险丝,10A/250V陶瓷速溶保险丝(10A延续测量<10秒)

交流电流

量程	准确度	K-9033	分辨力
200μA		(0.5%+4)	0.01μA
2000μA			0.0001mA
20mA		(0.8%+6)	0.001A
200mA			0.01A
10A		(1.0%+6)	0.1A

最大测量压降:200mV;最大输入电流10A; 过载保护:200m A/250V玻璃速溶保险丝,

10A/250V陶瓷速溶保险丝(10A延续测量<10秒);测量交流电流时副显示的频率门槛电压要

www.kaiside.com 频率显示; 频率响应: 正弦波及三角波为40Hz- 1Kz;其它波形为40Hz- 200Hz;
显示:真有效值;

电阻(Ω)

量程 \ 准确度	K-9033	分辨力
200 Ω	(0.3%+10)	0.01 Ω
2 k Ω	(0.3%+5)	0.1 Ω
20k Ω		1 Ω
200k Ω		10 Ω
2 M Ω		100 Ω
20M Ω	(1.2%+25)	1k Ω

开路电压: 小于3V; 过载保护: 550V直流或交流峰值;

注意事项: a: 在使用600 Ω 量程时, 应先将表笔短路, 测得引线电阻, 然后在实测中减去;

b: 测大于1M Ω 电阻时, 读数反映缓慢属于正常现象, 请待显示值稳定后再读数。

NCV测量

当拨盘致NCV测量功能, 该仪表靠近电场旁, 蜂鸣声根据电场强弱的变化, 蜂鸣声间断声也由强变弱。

量程	准确度	K-9033	分辨力
20nF		(3.5%+20)	1pF
200nF			10pF
2μF			0.1nF
20μF			1nF
200μF		(5.0%+10)	10nF
2000μF			100nF

过载保护:550V直流或交流峰值。

频率(f)

量程	准确度	K-9033	分辨力
10Hz		(0.01%+3)	0.001Hz
100Hz			0.01Hz
1kHz			0.1Hz
10kHz			1Hz
100kHz			10Hz
1MHz/20MHz			100Hz/1kHz

输入灵敏度:1.5V有效值;过载保护:550V直流或交流峰值(不超过10秒)。

温度

量程 \ 准确度	K-9033	分辨力
(-20-1000) °C	(1.0%+5) < 400 °C (1.5%+15) ≥ 400 °C	1 °C
(0-1832) °F	(0.75%+5) < 750 °F (1.5%+15) ≥ 750 °F	1 °F

二极管及通断性测试

量程	显示值	测试条件
	二极管正向压降	正向直流电流约1mA, 开路电压约3V
	蜂鸣器发声长响, 测试两点阻值小于(50±20)Ω	开路电压约3V 按“SELECT”为两档功能切换

过载保护:550V直流或交流峰值;

警告:为了安全在此量程禁止输入电压值!

显示屏

图一显示屏

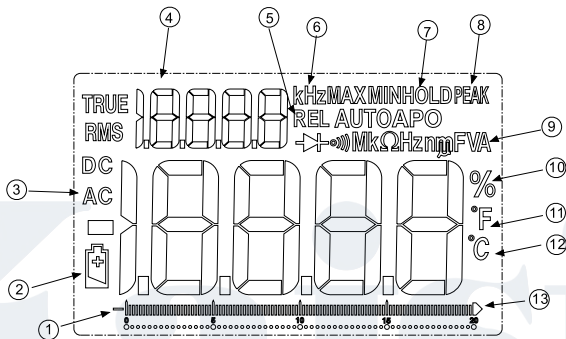

项目	说明	项目	说明
①	负极性显示	⑧	已选启用峰值保持
②	电池电量不足, 应立即更换	⑨	电流符号
③	交流符号	⑩	已选中占空比
④	副显示	⑪	已选中华氏度
⑤	已启用相对值测量	⑫	已选中摄氏度
⑥	副显示频率指示	⑬	模拟棒条指示
⑦	已启用显示保持		

操作面板

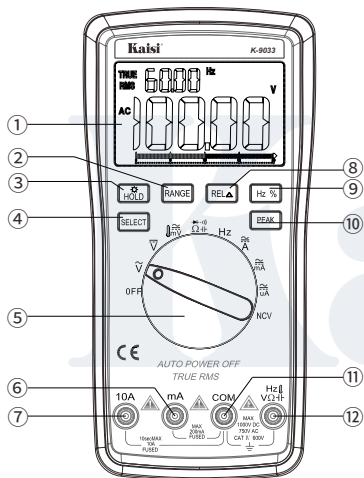

图二操作面板

项目	说明
①	LCD显示屏
②	手动量程转换键
③	数据保持键， 长按3秒为背光灯的开启与关闭
④	SELECT为功能选择键
⑤	功能转换开关
⑥	“mA”“+”输入端插孔
⑦	“10A”“+”输入端插孔
⑧	REL为相对值测量键
⑨	频率占空比转换键
⑩	“PEAK”为峰值测量键
⑪	COM输入端、负输入端插孔
⑫	电压、电阻、二极管、电容、频率、温度 “+”输入端插孔

测量交流电压和直流电压

1. 调节旋钮至 \tilde{V} 、 \bar{V} 或 Hz 以选择交流或直流电压。
2. 按“SELECT”可以在mVDC和mVAC电压之间切换。
3. 将红色测试导线连接至 V_{Ω} 端子,将探针接触正确的电路测试点,测量电压(如图三)。
4. 读取显示屏上测出的电压。

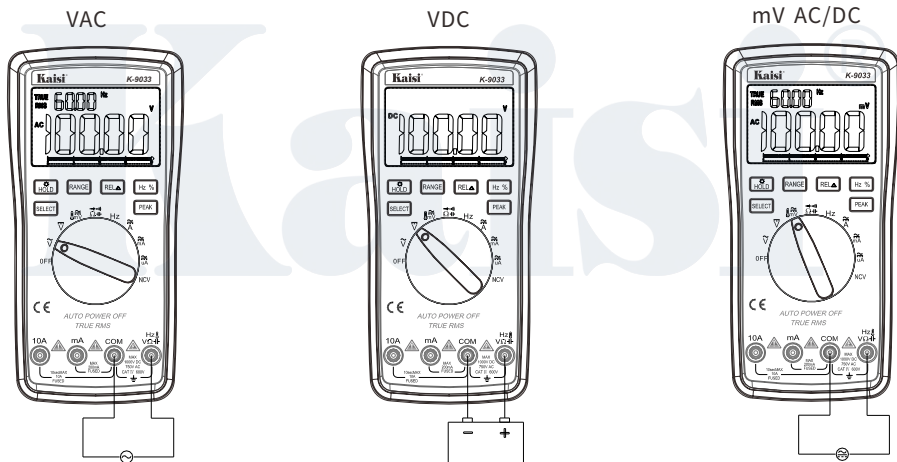

图三电压测量

直流电压测量

- 1.将黑表笔插入“COM”插孔,红表笔插入“V/ Ω /Hz”插孔;
 - 2.将量程开关转至“ \bar{V} ”或“ \approx ”档,测量值小于DC600mV选择“ \approx ”档,触发“SELECT”键DCmV/ACmV之间切换。
 - 3.将测试表笔可靠接触测试点,屏幕即显示被测电压值,为红表笔所接的该点电压极性。
- 注意: 1)输入电压切勿超过DC1000V或AC750V,如超过则有损坏仪表电路的危险;
- 2)测量高电压电路时,要特别注意避免触电;
 - 3)在完成所有的测量操作后,要断开表笔与被测电路的连接。

交流电压测量

- 1.将黑表笔插入“COM”插孔,红表笔插入“V/ Ω /Hz”插孔;
 - 2.将量程开关转至“ \bar{V} ”或“ \approx ”档,测量值小于AC600mV选择“ \approx ”档,触发“SELECT”键选择ACmV测量功能。
- 注意: 1)测试前各量程存在一些残留数字,但不影响测量准确度;
- 2)输入电压切勿超过于750Vrms,如超过则有损坏仪表电路的危险;
 - 3)测量高电压电路时,要特别注意避免触电;
 - 4)在完成所有的测量操作后,要断开表笔与被测电路的连接。

测量交流电流或直流电流

⚠️⚠️ 警告

为了防止可能发生的电击、火灾或人身伤害,测量电流时,先断开电源电路,然后再将电表连接到电路中,将产品与电路串联起来。

- 1.将转开关转至“ \tilde{A} ”“ \tilde{mA} ”“ $\tilde{\mu A}$ ”电流档。
- 2.按“SELECT”键选择在交流和直流电流之间切换。
- 3.根据要测量的电流将红色测试导线连接至A或mA, uA端子, 并将黑色测试导线接至COM端子。如图四
- 4.断开待测的电路路径,然后将测试导线衔接断开并施用电源。
- 5.阅读显示屏上测出的电流。

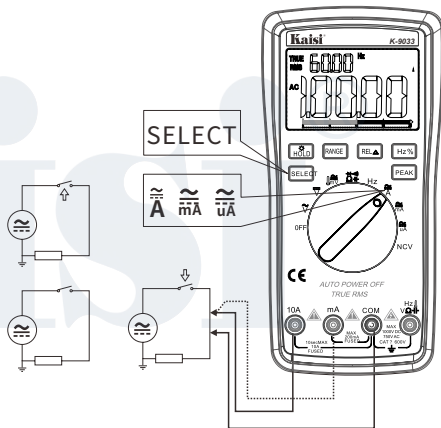

图四电流测量

测量交流电流或直流电流

- 1.将黑表笔插入“COM”插孔,红表笔插入“mA”或“uA”插孔中(最大为200mA),或红表笔插入“10A”中(最大为10A);当前默认为直流电流,“SELECT”为交直流电流转换键。
- 2.将量程开关转至相应电流档位上,然后将仪表串入待测回路中,被测电流值及红表笔点的电流极性将同时显示在屏幕上。

注意:

- 1)在仪表串联到待测回路之前,应先将回路中的电源关闭;
- 2)如果事先对被测电流范围没有概念,应将量程开关转至到最高的档位,然后显示值转至相应档上;如屏幕显“OL”,表明已超过量程范围,须将量程开关转至相应档位上;
- 3)最大输入电流为200mA或者10A(视红表笔插入位置而定),过大的电流将会损坏mA档的保险丝,在测量10A要注意,千万要小心,每次测量时间不得大于10秒,过大的电流将使电路发热,甚至损坏仪表;
- 4)当表笔插在电流输入端口上时,切勿把表笔测试针并联到任何电路上,会损坏保险丝和仪表;
- 5)当完成所有的测量操作后,应先关断电源再断开表笔与被测电路的连接,对大电流的测量更为重要。
- 6)禁止在电流插孔与“COM”插孔之间输入高于36V直流、25V交流电压。

电阻测量

- 1.将旋转开关转至“ Ω ”，确保已切断待测电源电路。
- 2.将红色测试导线连接至VR端口,并将黑色测试导线 连接至COM端子,如图五。
- 3.将探针接触想要的电路测试点，测量电阻。
- 4.阅读显示屏上的阻值。

通断性测试

旋转电阻模式后，按“SELECT”进入蜂鸣器测量，当测量阻值小于50 Ω 时，蜂鸣器将连续响起。

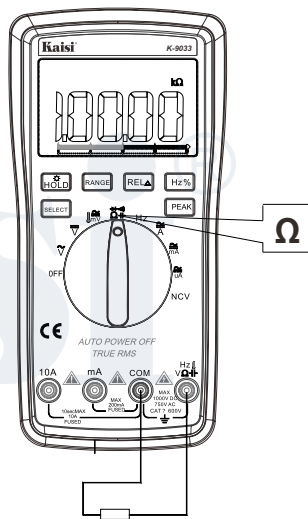

图五电阻测量

电阻测量

- 1.将黑表笔插入“COM”插孔,红表笔插入“V/ Ω /Hz”插孔;
- 2.拨盘旋至“ Ω ”档,触发“SELECT”键,选择电阻档自动测量。
- 3.将两表笔跨接在被测电阻上。

注意:

- 1) 如果被测电阻开路或阻值超过所选的量程值,则屏幕会显“OL” 测量电阻值超过1 M Ω 以上时,读数需几秒时间才能稳定,这在测量高电阻时是正常的;
- 2) 测量低阻时,表笔会带来内阻,为获得 确读数,可以先记录表笔短路值,在测量读数 中减去表笔短路时的数值;
- 3) 测量在线电阻时,必须将被测电路所有电源关断且所有电容完全放电,才能保证测量值 的正确;
- 4) 请勿在电阻量程输入电压,这是绝对禁止的,虽然仪表在该档位上有电压防护功能!

电容测量

- 1.将黑表笔插入“COM”插孔,红表笔插入“V/ Ω /Hz”插孔;
- 2.拨盘旋至“ ”档,触发“SELECT”键,选择电容档自动测量。
- 3.然后将测试表笔跨接在被测电容两端。

注意:

- 1)用20nF档测量电容时,屏幕显示值可能有残留读数,此数为表笔的分布电容,为确读数,可在测量后,减去此数值;
- 2)大电容档测量严重漏电或击穿电容时,将显示一些数值且不稳定;测量大电容时,读数需要几秒钟时间才能稳定,这在测量大电容时是正常的;
- 3)请在测试电容容量之前,对电容应充分地放电,以防止损坏保险管和仪表。
- 4) 单位: $1\text{F}=1000\text{mF}$
 $1\text{mF}=1000\mu\text{F}$
 $1\mu\text{F}=1000\text{nF}$
 $1\text{nF}=1000\text{pF}$

二极管及通断测试

- 1.将黑表笔插入“COM”插孔,红表笔插入“V/ Ω /Hz”插孔;(注意红表笔极性为“+”);
- 2.将量程开关置“ $\overrightarrow{\Omega}$ ”档,触发“SELECT”键,选择二极管测量,并将表笔连接到待测试二极管,读数为二极管正向压降的近似值,对于硅PN结而言,一般约为500mV~800mV确认为正常值;若被测二极管开路或极性反接,则显示“OL”;
- 3.触发“SELECT”键,选择蜂鸣器测量,将表笔连接到待测线路的两点,如果内置坏蜂鸣器发声且通断报警指示灯亮,则两点之间电阻值低于约(50 \pm 20) Ω 。

注意:

禁止在“ $\overrightarrow{\Omega}$ ”档输入电压,以免损坏仪表。

频率测量

- 1.将表笔或屏蔽电缆插入“COM”和“V/ Ω /Hz”插孔;
- 2.将量程开关转至频率档上,将表笔或电缆跨接在信号源或被测负载上。

注意: 1) 输入超过10Vrms时,可以读数,但可能超差;

2) 在噪声环境下,测量小信号时最好使用屏蔽电缆;

3) 在测量高电压电路时,特要注意避免触电;

4) 禁止输入超过250V直流或交流峰值的电C值,以免损坏仪表。

数据保持/背光

按下“HOLD”键为数据保持

长按“HOLD”3秒,背光灯亮,再长按3秒,背光关闭,15秒后背光自动关闭。

自动关机

当仪表停止使用约15分钟后,仪表便自动断电进入休眠状态;

若要重新启动电源,拨盘至OFF档,转动旋钮拨盘转到其它档位。

按“SELECT”键,同时开启电源开关,

屏幕上“APO”符号消失,将取消自动功能。

故障排除

如果您的仪表不能正常工作,下面的方法可以帮您快速解决一般问题。如果故障仍排除不了,请与维修中心或经销商联系。

故障现象	检查部位及方法
没显示	电源未接通 换电池
 符号出现	换电池
电流没输入	换保险丝
显示误差大	换电池

本说明书如有改变,恕不通知;

本说明书的内容被认为是正确的,若用户发现有错误、遗漏等,请与生产厂家联系;

本公司不承担由于用户错误操作所引起的事故和危害;

本说明书所讲述的功能,不作为将产品用做特殊用途的理由。

仪表保养

该系列表是一台精密仪器,使用者不要随意更改电路。

1. 请注意防水、防尘、防摔;
2. 不宜在高温高湿、易燃易爆和强磁场环境下存放、使用仪表;
3. 请使用湿布和温和的清洁剂清洁仪表外表, 不要使用研磨剂及酒精等烈性溶剂;
4. 如果长时间不使用, 应取出电池, 防止电池漏液腐蚀仪表;

更换电池

注意电池使用情况, 屏幕显示出“”符号时, 应更换电池。

步骤如下:

- 1. 拧出固定电池盖的螺丝, 退出电池盖;
- 2. 取下电池, 换上一个新的电池, 虽然任何标准电池都可使用, 但为加长使用时间, 最好使用碱性电池;
- 3. 装上电池盖, 拧紧螺丝。

更换保险丝

更换保险丝时, 请使用规格型号相同的保险丝。

www.kaisitool.com



关注官方微博 最新消息

最新产品预告, 产品使用教程, 市场促销活动。



扫描二维码 认准官网正品

提防假冒, 认准唯一官方网站, 认准官方正品。

Kaisi®

恒惟工具, 用心服务全球!

广州金卡思贸易有限公司

GUANGZHOU KaisiKing Trading Co., Ltd.

广州市荔湾区恒惟电子配件商行

GUANGZHOU HENGWEI ELECTRONIC ACCESSORIES

Tel\Fax:86-757-85852080

广东省佛山市南海区盐步东秀高村工业区4号3楼

www.kaisidesign.com